

STRUCTURE

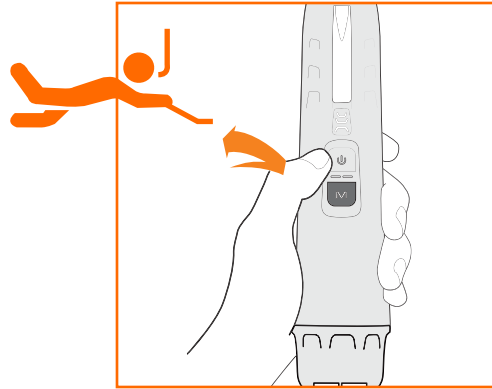

- ❶ Detection coil
- ❷ Effective area
- ❸ Flashlight LED
- ❹ Indication LED
- ❺ Buzzer vent
- ❻ Power button
- ❼ Mode button
- ❽ Battery cap
- ❾ Anchor loop

QUICK START



Snorkeling mode(0~10M depth)

Power on/off (default)

Press the Power button once to power on. Press again to power off.

Power on/off (retune on)

Press the Power button once to power on. Press 1S to power off.

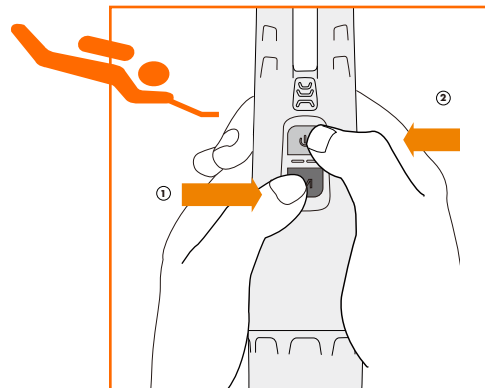

Dive mode (10~60M, read P12 for detail)

Hold two buttons for 2sec to enter dive mode. The red light will flash 5 times and vibration will start. Click mode 3 times quickly to switch back to shallow water mode.

Warning

POSITIVE BUOYANCY
ALWAYS ATTACH THE LANYARD

REGISTER YOUR PRODUCTS TO ACTIVE WARRANTY

Deteknix Scuba Tector provides a limited warranty to the original purchaser of its products against all defects in original workmanship and material, under normal use and service, for ONE year from the date of purchase with the following exceptions:

- All warranties void if electronic part opened.
- Batteries are warranted for 90 days.
- Cosmetic discoloration of surfaces.
- Water flooding caused from battery cap seal.

Deteknix will not be liable for any further loss, damages, or expenses, including incidental or consequential damages directly or indirectly arising from the sale or use of this product.

DO & DON'T

- Always make sure battery cap is tightened before entering the water. Only open battery cap with clean hand.
- Always store your detector fully charged.
- Always rinse equipment in fresh water after every dive.
- Always apply silicone grease after cleaning O-ring.
- Only open battery cap by clean hand.
- Never leave your equipment in the rinse bucket. It may be damaged by other equipment.

SENSITIVITY

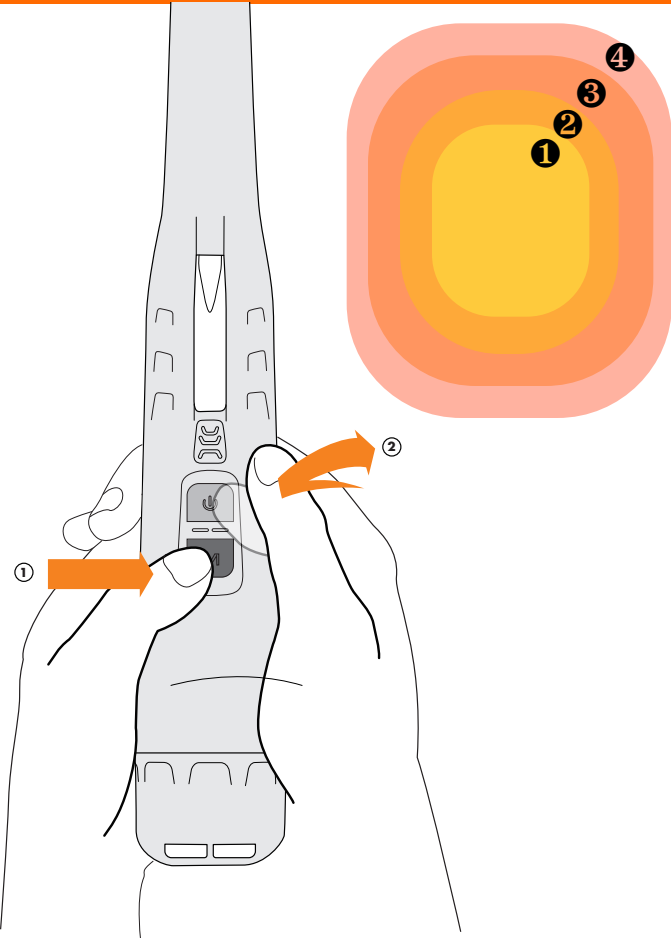

When powered on, keep pressing Mode button and quickly press power button to change sensitivity level from 1~4(highest level) . Each level will sound an extra beep until level 4 which will sound a long beep.

ALARM

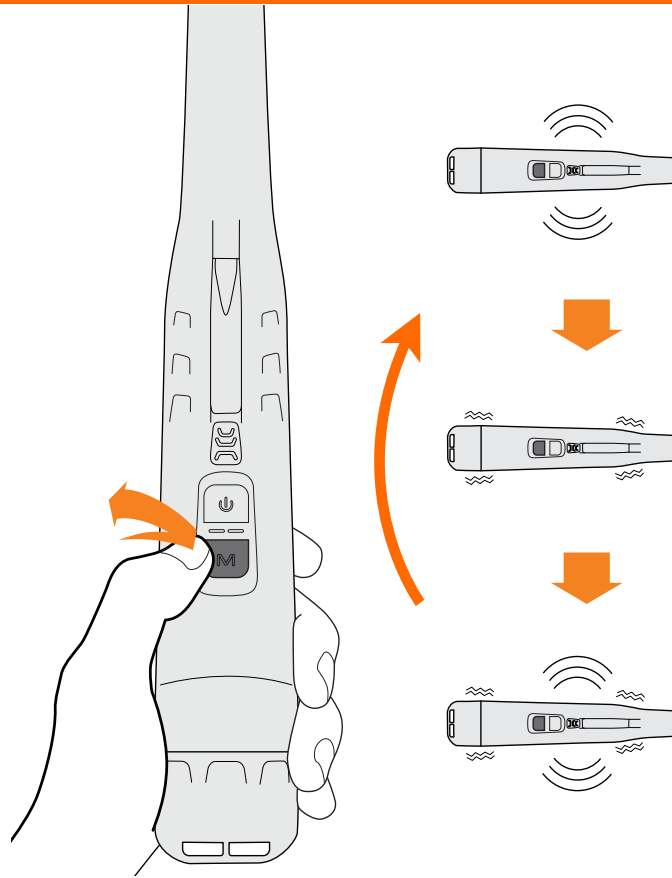

When powered on, press Mode button quickly to switch through the three different alarm modes (Beep, Vibration only, Beep and Vibrate)

Losing alert. The probe will start to beep at certain frequency when no alarm or operating for 3 minutes. This is to remind the user to power off or to pick up and re-use.

Power saving feature. The probe will turnoff automatically after 3 minutes alarming under losing mode to save battery.

PROGRAMING

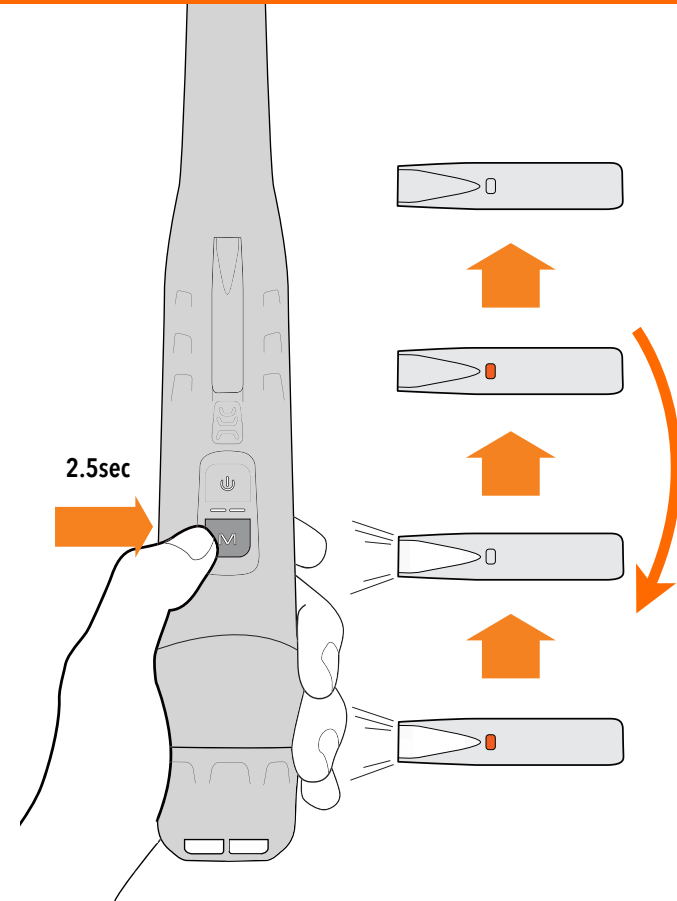

While powered on, keep pressing on Mode button for 2.5 seconds to enter LED light control programing. While indicator and flashlight both light up, quick press on mode button to switch from four modes(indicator only, flash light only, all off, all on)

Turn on/off tuning function. Under Expert Mode, quick press power button once to activate/de-activate the retune function.

RETRIEVE

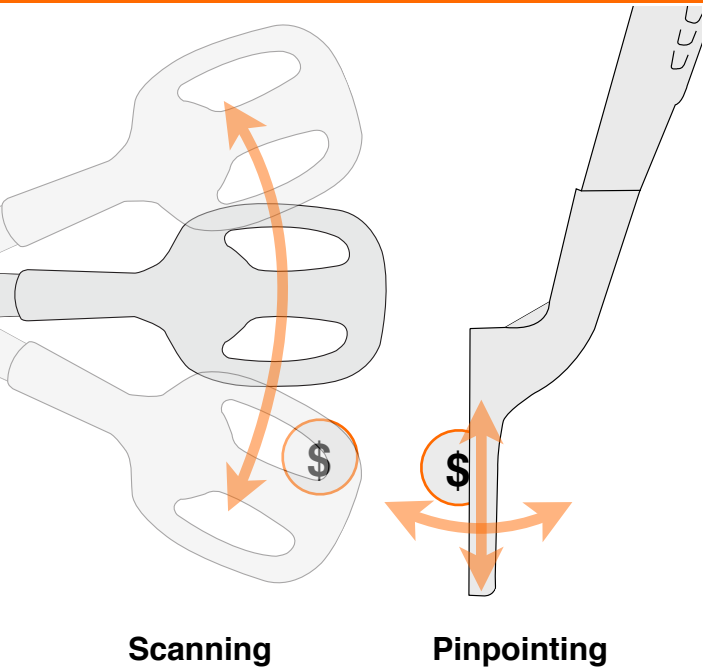

Scanning

Pinpointing

- Swing the detector in overlap style.
- You can use side coil to pinpoint the target.
- Retune function. The retuning function is designed for ground balance to high mineralization condition or narrow down the target position. Xpointer family are powered by Pulse Induction technology which will not produce any falsing to saltwater or black sand environment. You can use this function to help you get closer to the target. Just quick press the power button once to mute the alarm and move again until you hear the target. You can also turn it off to make the operating simple.

LOW BAT.

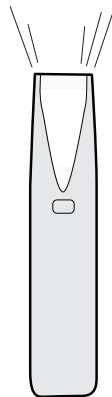

Low battery

When the probes flash light start to blink at a certain frequency, it means it needs recharging. You can still use it but the sensitivity will be a little lower.

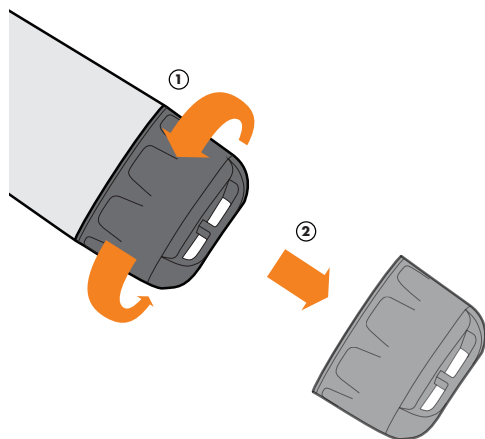

Remove battery cap

Hold and twist the battery cap anti-clockwise to loosen it.

Hold and twist clockwise to re-tight.

Beware of cross threading the cap and body when tightening the cap.

RECHARGING

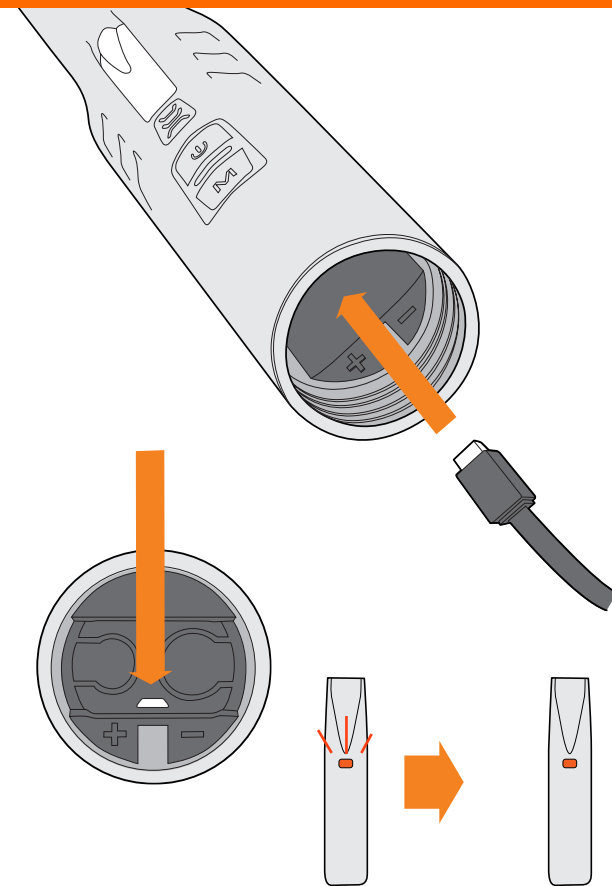

- We strongly recommend you to use a quality wall charger when re-charge the probe. It will takes about 2~3 hours to fully charge
- Laptop or desktop computer's USB port produce lower power which could make the recharging longer than wall charger.
- The probe will stop blinking when it is fully charged. You can leave the USB cable inside the recharge house after recharging.

MAINTENANCE

Cleaning the Device

1. Use tap water or dampen a clean cloth with a mild detergent solution. 2. Wipe the device with the damp cloth. 3. Thoroughly dry the device. **Avoid chemical cleaners and solvents which can damage plastic components.**

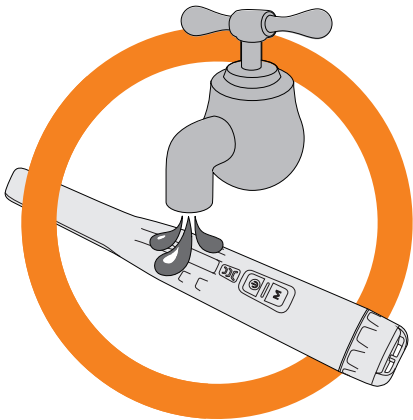

The device is waterproof to 60M/200FT. It can withstand immersion in 60M/200FT of water for 30 minutes. After submersion, be certain to wipe dry and air dry the device before using or charging.

Do not store the device where prolonged exposure to extreme temperatures can occur because it can cause permanent damage.

O-RING

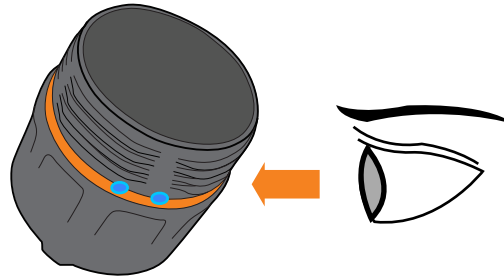

Clean dust sand and fabric if spotted. Even a tiny grain of sand will cause water ingress.

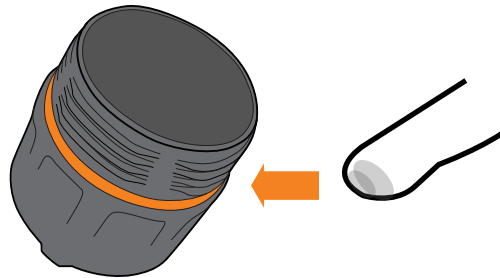

Apply quality silicone O-ring grease thoroughly.

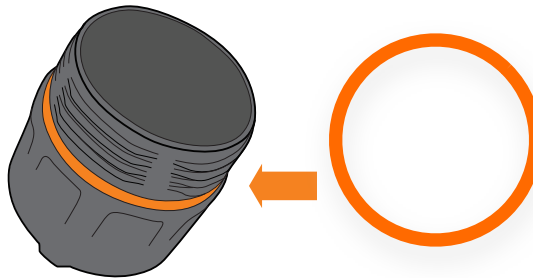

Change O-ring once a year at least. Use qualified original part only.

DIVE MODE CONTROL

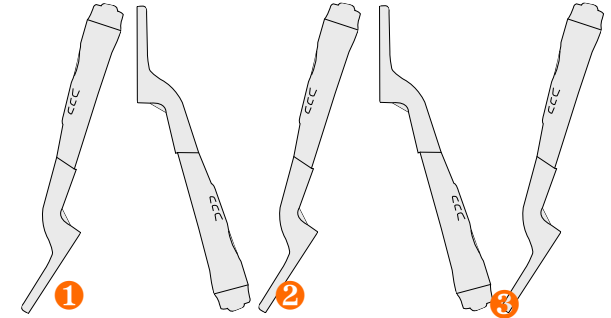

Activate alarm: tilt it up side down 3X to **activate** the detection mode(DMA). The detector is ready to use. The red indication will blink twice every 3 sec. You are ready to search.

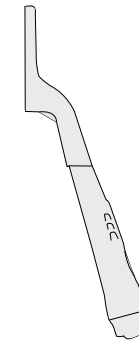

keep 5sec~

Mute alarming: Keep the coil up for 5 seconds to turn back to **standby** mode (DMS). It will come with 1sec alarm and the sensor is now stop working. The red indication will blink once every 3 sec. The unit is still powered on until power off at snorkeling mode.

Notice:

- Under deep water when two buttons been pressed down, the detector will switch to dive mode automatically.
- No losing alert and power saving under diving mode.